

## SIT timing pulleys - EAGLE

The SIT **EAGLE** pulleys, manufactured with innovative high-tech equipments, have been specifically designed to fit with the **SILENT SYNC**® belt.

This combination, thanks to the continuous and gradual engagement of the belt with the pulleys, is the best solution existing today in terms of noise abatement, wear reduction and vibration dampening.

The **EAGLE** transmission is the only one that guarantees the self-alignment, even under high load conditions or extreme peripheral speed. For this reason **EAGLE** pulleys don't need flanges; the result is a more compact drive system.

The standard **EAGLE** pulleys are statically balanced.

### Solid hub

Material: steel/spheroidal cast iron/cast iron/aluminum.  
Finishing: protective surface treatment.

Pitch:

- 5M
- 8M
- 10M
- 14M



### For mounting taper bushing SER-SIT®

Material: steel/spheroidal cast iron/cast iron.  
Finishing: protective surface treatment.

Pitch:

- 14M

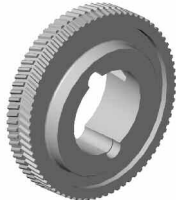

### Special executions

Upon request, SIT is able to design and manufacture any type of pulley based on customer requirements.

For peripheral speed exceeding 33 m/s it is strongly recommended to use steel as material of construction.

In case of aluminium execution is possible to reduce the pulley abrasion, due to the nylon belt coating, thanks to a high thickness anodization coating on the pulley teeth (on request).

$$\text{peripheral speed [m/s]} = \frac{\text{pulley diameter [mm]} \cdot \text{rpm}}{19100}$$

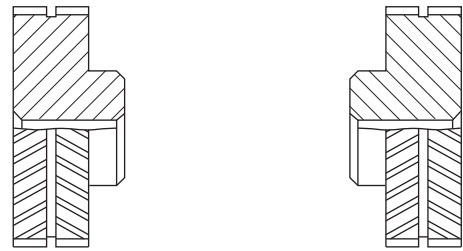

**Attention:** for non-standard executions, it is important to indicate the orientation of the teeth relative to the position of the hub (as per above pictures).

## TOLERANCES

### Pulley diameter tolerances

External Diameter [mm]	Tolerances [mm]
up to 101,6	-0,00 +0,13
from 101,7 to 177,8	-0,00 +0,13
from 177,9 to 304,8	-0,00 +0,15
from 304,9 to 508,0	-0,00 +0,18
from 508,1 to 750,0	-0,00 +0,20

### Radial circular runout

External Diameter [mm]	Tolerances [mm]
up to 101,6	0,13
from 101,7 to 177,8	0,13
from 177,9 to 304,8	0,15
from 304,9 to 508,0	0,20
from 508,1 to 750,0	0,30

### Cylindricity tolerance

Pulley width	Tolerances
for any 100 mm	0,1 mm without exceeding the external diameter tolerance

### Protective coating

All (steel and cast iron) pulleys are treated with surface process that gives greater resistance against oxidizing agents. This treatment does not modify the profile or the dimensions of the pulleys.

On request SIT can provide a wide range of special coating, related to the customer specific needs or environmental critical conditions.

### Note

Due to a constant improvement of our products, technical data of the pulleys may be subject to changes. For technical and production reasons, in some cases materials other than those indicated in the catalogue may be used. For confirmation of the material actually available, please contact customer service.

# Dimensions of timing pulleys EAGLE - solid hub pitches 8M - 14M



Part Number	PE	Y	-32S	-MPB
EAGLE timing pulley - solid hub				
Belt width				
Number of teeth				
Solid hub				

**Type "Yellow" Y - belt width W = 16 mm**

**8M**

Code	Teeth nr.	Type	R [mm]	S [mm]	U [mm]	H [mm]	d [mm]	W [mm]	Y [mm]	Z [mm]	Max bore [mm]	Material
PEY-18S-MPB	18	1	45,84	44,47	-	38,4	12,7	17,0	27,0	10,0	26,0	steel
PEY-20S-MPB	20	1	50,93	49,56	-	40,7	12,7	17,0	29,0	12,0	27,0	
PEY-22S-MPB	22	1	56,02	54,65	-	45,9	12,7	17,0	29,0	12,0	31,0	
PEY-24S-MPB	24	1	61,12	59,75	-	51,0	12,7	17,0	33,0	16,0	34,0	
PEY-25S-MPB	25	1	63,66	62,29	-	53,5	12,7	17,0	33,0	16,0	36,0	
PEY-26S-MPB	26	1	66,21	64,84	-	57,8	12,7	17,0	33,0	16,0	39,0	
PEY-28S-MPB	28	1	71,30	69,93	-	61,0	12,7	17,0	33,0	16,0	41,0	
PEY-30S-MPB	30	1	76,40	75,03	-	67,0	12,7	17,0	33,0	16,0	45,0	
PEY-32S-MPB	32	1	81,49	80,12	-	72,0	12,7	17,0	33,0	16,0	48,0	
PEY-34S-MPB	34	1	86,58	85,21	-	77,0	12,7	17,0	33,0	16,0	51,0	
PEY-36S-MPB	36	1	91,68	90,30	-	82,0	12,7	17,0	33,0	16,0	55,0	
PEY-38S-MPB	38	1	96,77	95,40	-	87,0	12,7	17,0	33,0	16,0	58,0	
PEY-40S-MPB	40	1	101,86	100,49	-	92,0	12,7	17,0	33,0	16,0	62,0	
PEY-44S-MPB	44	1	112,05	110,68	-	102,0	12,7	17,0	33,0	16,0	68,0	
PEY-45S-MPB	45	1	114,59	113,22	-	105,0	12,7	17,0	33,0	16,0	70,0	
PEY-48S-MPB	48	1	122,23	120,86	-	112,0	12,7	17,0	33,0	16,0	75,0	
PEY-50S-MPB	50	1	127,33	125,96	-	118,0	12,7	17,0	33,0	16,0	79,0	
PEY-52S-MPB	52	1	132,42	131,05	-	123,0	12,7	17,0	33,0	16,0	82,0	
PEY-56S-MPB	56	1	142,61	141,24	-	133,0	12,7	17,0	33,0	16,0	89,0	
PEY-60S-MPB	60	1	152,79	151,42	-	143,0	12,7	17,0	33,0	16,0	96,0	
PEY-63S-MPB	63	2	160,43	159,06	139,0	110,0	12,7	17,0	33,0	16,0	73,0	GS400
PEY-64S-MPB	64	2	162,98	161,61	142,0	110,0	12,7	17,0	33,0	16,0	74,0	
PEY-68S-MPB	68	2	173,17	171,79	152,0	110,0	12,7	17,0	33,0	16,0	74,0	
PEY-72S-MPB	72	2	183,35	181,98	162,0	110,0	12,7	17,0	33,0	16,0	74,0	
PEY-75S-MPB	75	2	190,99	189,62	170,0	110,0	12,7	17,0	33,0	16,0	73,0	
PEY-76S-MPB	76	2	193,54	192,17	172,0	110,0	12,7	17,0	33,0	16,0	74,0	
PEY-80S-MPB	80	2	203,72	202,35	182,0	110,0	12,7	17,0	33,0	16,0	73,0	GG
PEY-90S-MPB	90	2	229,19	227,82	208,0	110,0	25,4	17,0	33,0	16,0	73,0	
PEY-112S-MPB	112	2	285,21	283,84	264,0	110,0	25,4	17,0	33,0	16,0	73,0	
PEY-140S-MPB	140	2	356,52	355,15	335,0	110,0	25,4	17,0	33,0	16,0	73,0	
PEY-180S-MPB	180	3	458,38	457,01	433,0	150,0	25,4	17,0	33,0	16,0	100,0	
PEY-224S-MPB	224	3	570,43	569,06	545,0	150,0	25,4	17,0	33,0	16,0	100,0	

GS400 = spheroidal cast iron - GG = grey cast iron

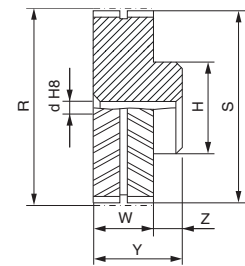

1

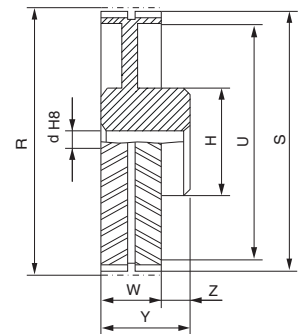

2

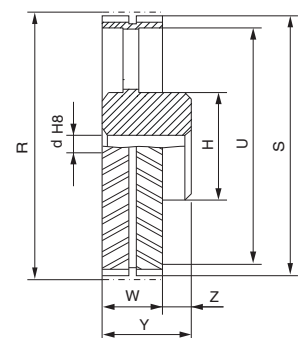

3

# Dimensions of timing pulleys EAGLE - solid hub



Type "White" W - belt width  $W = 32 \text{ mm}$

8M

Code	Teeth nr.	Type	R [mm]	S [mm]	U [mm]	H [mm]	d [mm]	W [mm]	Y [mm]	Z [mm]	Max bore [mm]	Material
PEW-18S-MPB	18	1	45,84	44,47	-	38,4	12,7	33,0	43,0	10,0	26,0	steel
PEW-20S-MPB	20	1	50,93	49,56	-	40,7	12,7	33,0	45,0	12,0	27,0	
PEW-22S-MPB	22	1	56,02	54,65	-	45,9	12,7	33,0	45,0	12,0	31,0	
PEW-24S-MPB	24	1	61,12	59,75	-	51,0	12,7	33,0	49,0	16,0	34,0	
PEW-25S-MPB	25	1	63,66	62,29	-	53,5	12,7	33,0	49,0	16,0	36,0	
PEW-26S-MPB	26	1	66,21	64,84	-	57,8	12,7	33,0	49,0	16,0	39,0	
PEW-28S-MPB	28	1	71,30	69,93	-	62,0	12,7	33,0	49,0	16,0	41,0	
PEW-30S-MPB	30	1	76,40	75,03	-	67,0	12,7	33,0	49,0	16,0	45,0	
PEW-32S-MPB	32	1	81,49	80,12	-	72,0	12,7	33,0	49,0	16,0	48,0	
PEW-34S-MPB	34	1	86,58	85,21	-	77,0	12,7	33,0	49,0	16,0	51,0	
PEW-36S-MPB	36	1	91,68	90,30	-	82,0	12,7	33,0	49,0	16,0	55,0	
PEW-38S-MPB	38	1	96,77	95,40	-	87,0	12,7	33,0	49,0	16,0	58,0	
PEW-40S-MPB	40	1	101,86	100,49	-	92,0	12,7	33,0	49,0	16,0	62,0	
PEW-44S-MPB	44	1	112,05	110,68	-	102,0	12,7	33,0	49,0	16,0	68,0	
PEW-45S-MPB	45	1	114,59	113,22	-	105,0	12,7	33,0	49,0	16,0	70,0	
PEW-48S-MPB	48	1	122,23	120,86	-	112,0	12,7	33,0	49,0	16,0	75,0	
PEW-50S-MPB	50	1	127,33	125,96	-	118,0	12,7	33,0	49,0	16,0	79,0	
PEW-52S-MPB	52	1	132,42	131,05	-	123,0	12,7	33,0	49,0	16,0	82,0	
PEW-56S-MPB	56	1	142,61	141,24	-	133,0	12,7	33,0	49,0	16,0	89,0	
PEW-60S-MPB	60	1	152,79	151,42	-	143,0	12,7	33,0	49,0	16,0	96,0	
PEW-63S-MPB	63	1	160,43	159,06	-	151,0	12,7	33,0	49,0	16,0	101,0	
PEW-64S-MPB	64	1	162,98	161,61	-	153,0	12,7	33,0	49,0	16,0	102,0	
PEW-68S-MPB	68	2	173,17	171,79	152,0	120,0	25,4	33,0	49,0	16,0	80,0	GS400
PEW-72S-MPB	72	2	183,35	181,98	162,0	120,0	25,4	33,0	49,0	16,0	80,0	
PEW-75S-MPB	75	2	190,99	189,62	170,0	120,0	25,4	33,0	49,0	16,0	80,0	
PEW-76S-MPB	76	2	193,54	192,17	172,0	120,0	25,4	33,0	49,0	16,0	80,0	
PEW-80S-MPB	80	2	203,72	202,35	182,0	120,0	25,4	33,0	49,0	16,0	80,0	
PEW-90S-MPB	90	2	229,19	227,82	208,0	120,0	25,4	33,0	49,0	16,0	80,0	
PEW-112S-MPB	112	2	285,21	283,84	264,0	120,0	25,4	33,0	49,0	16,0	80,0	GG
PEW-140S-MPB	140	2	356,52	355,15	335,0	150,0	25,4	33,0	49,0	16,0	100,0	
PEW-180S-MPB	180	3	458,38	457,00	433,0	150,0	25,4	33,0	49,0	16,0	100,0	
PEW-224S-MPB	224	3	570,43	569,04	545,0	150,0	25,4	33,0	49,0	16,0	100,0	

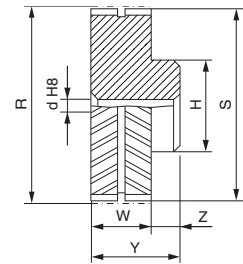

1

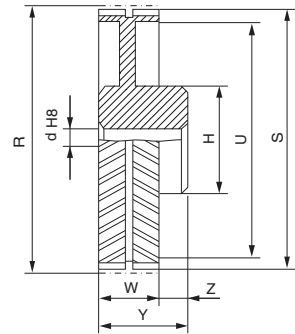

2

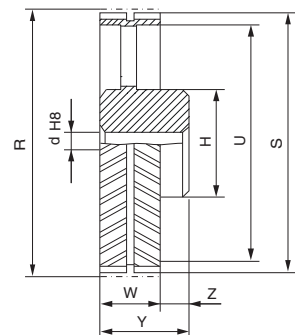

3

GS400 = spheroidal cast iron - GG = grey cast iron

# Dimensions of timing pulleys EAGLE - solid hub



Type "Purple" P - belt width  $W = 64 \text{ mm}$

8M

Code	Teeth nr.	Type	R [mm]	S [mm]	U [mm]	H [mm]	d [mm]	W [mm]	Y [mm]	Z [mm]	Max bore [mm]	Material	
PEP-18S-MPB	18	1	45,84	44,47	-	38,4	12,7	65,0	85,0	20,0	26,0	steel	
PEP-20S-MPB	20	1	50,93	49,55	-	40,7	12,7	65,0	85,0	20,0	27,0		
PEP-22S-MPB	22	1	56,02	54,64	-	45,9	12,7	65,0	85,0	20,0	31,0		
PEP-24S-MPB	24	1	61,12	59,74	-	51,0	12,7	65,0	85,0	20,0	34,0		
PE P-25S-MPB	25	1	63,66	62,28	-	53,5	12,7	65,0	85,0	20,0	36,0		
PEP-26S-MPB	26	1	66,21	64,83	-	57,8	12,7	65,0	85,0	20,0	39,0		
PEP-28S-MPB	28	1	71,30	69,92	-	62,0	12,7	65,0	85,0	20,0	41,0		
PEP-30S-MPB	30	1	76,39	75,01	-	67,0	12,7	65,0	85,0	20,0	45,0		
PEP-32S-MPB	32	1	81,49	80,11	-	72,0	12,7	65,0	85,0	20,0	48,0		
PEP-34S-MPB	34	1	86,58	85,20	-	77,0	12,7	65,0	85,0	20,0	51,0		
PEP-36S-MPB	36	1	91,67	90,29	-	82,0	12,7	65,0	85,0	20,0	55,0		
PEP-38S-MPB	38	1	96,77	95,39	-	87,0	12,7	65,0	85,0	20,0	58,0		
PEP-40S-MPB	40	1	101,86	100,48	-	92,0	12,7	65,0	85,0	20,0	62,0		
PEP-44S-MPB	44	1	112,05	110,67	-	102,0	12,7	65,0	85,0	20,0	68,0		
PEP-45S-MPB	45	1	114,59	113,21	-	105,0	12,7	65,0	85,0	20,0	70,0		
PEP-48S-MPB	48	1	122,23	120,85	-	112,0	25,4	65,0	85,0	20,0	75,0		
PEP-50S-MPB	50	1	127,32	125,94	-	118,0	25,4	65,0	85,0	20,0	79,0		
PEP-52S-MPB	52	1	132,42	131,04	-	123,0	25,4	65,0	85,0	20,0	82,0		
PEP-56S-MPB	56	1	142,60	141,22	-	133,0	25,4	65,0	85,0	20,0	89,0		
PEP-60S-MPB	60	1	152,79	151,41	-	143,0	25,4	65,0	85,0	20,0	96,0		
PEP-63S-MPB	63	1	160,43	159,05	-	151,0	25,4	65,0	85,0	20,0	101,0		
PEP-64S-MPB	64	1	162,98	161,60	-	153,0	25,4	65,0	85,0	20,0	102,0		
PEP-68S-MPB	68	2	173,17	171,79	152,0	120,0	25,4	65,0	85,0	20,0	80,0		GS400
PEP-72S-MPB	72	2	183,35	181,97	162,0	120,0	25,4	65,0	85,0	20,0	80,0		
PEP-75S-MPB	75	2	190,99	189,61	170,0	120,0	25,4	65,0	85,0	20,0	80,0		
PEP-76S-MPB	76	2	193,53	192,15	172,0	120,0	25,4	65,0	85,0	20,0	80,0		
PEP-80S-MPB	80	2	203,72	202,34	182,0	120,0	25,4	65,0	85,0	20,0	80,0		
PEP-90S-MPB	90	2	229,18	227,80	208,0	120,0	25,4	65,0	85,0	20,0	80,0		
PEP-112S-MPB	112	2	285,21	283,83	264,0	120,0	25,4	65,0	85,0	20,0	80,0	GG	
PEP-140S-MPB	140	2	356,51	355,14	335,0	150,0	25,4	65,0	85,0	20,0	100,0		
PEP-180S-MPB	180	3	458,37	457,00	433,0	150,0	25,4	65,0	85,0	20,0	100,0		
PEP-224S-MPB	224	3	570,41	569,04	545,0	150,0	25,4	65,0	85,0	20,0	100,0		

GS400 = spheroidal cast iron - GG = grey cast iron

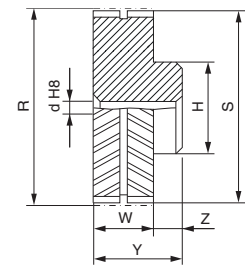

1

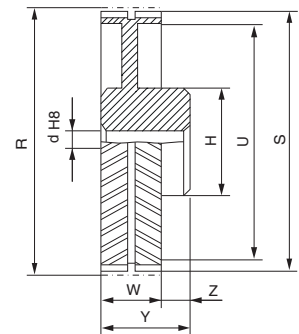

2

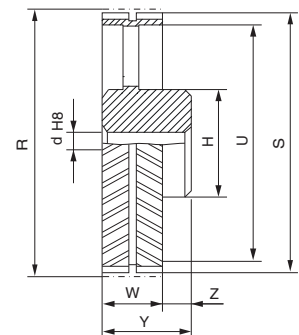

3

# Dimensions of timing pulleys EAGLE - solid hub



## Type "Blue" B - belt width W = 35 mm

14M

Code	Teeth nr.	Type	R [mm]	S [mm]	U [mm]	H [mm]	d [mm]	W [mm]	Y [mm]	Z [mm]	Max bore [mm]	Material
PEB-28S-MPB	28	1	124,78	121,99	-	105,0	25,4	37,0	53,0	16,0	70,0	steel
PEB-30S-MPB	30	1	133,69	130,90	-	114,0	25,4	37,0	53,0	16,0	76,0	
PEB-32S-MPB	32	1	142,61	139,81	-	123,0	25,4	37,0	53,0	16,0	82,0	
PEB-34S-MPB	34	1	151,52	148,73	-	132,0	25,4	37,0	53,0	16,0	88,0	
PEB-36S-MPB	36	1	160,43	157,64	-	141,0	25,4	37,0	53,0	16,0	94,0	
PEB-38S-MPB	38	1	169,35	166,55	-	150,0	25,4	37,0	53,0	16,0	100,0	
PEB-40S-MPB	40	1	178,26	175,46	-	159,0	25,4	37,0	53,0	16,0	106,0	
PEB-43S-MPB	43	1	191,63	188,83	-	172,0	25,4	37,0	53,0	16,0	115,0	
PEB-45S-MPB	45	1	200,54	197,75	-	181,0	25,4	37,0	53,0	16,0	121,0	
PEB-48S-MPB	48	1	213,91	211,12	-	195,0	25,4	37,0	53,0	16,0	130,0	
PEB-50S-MPB	50	2	222,82	220,03	185,0	150,0	25,4	37,0	53,0	16,0	100,0	GS400
PEB-56S-MPB	56	2	249,56	246,77	212,0	150,0	25,4	37,0	53,0	16,0	100,0	
PEB-60S-MPB	60	2	267,39	264,59	230,0	150,0	25,4	37,0	53,0	16,0	100,0	
PEB-63S-MPB	63	2	280,76	277,96	243,0	150,0	25,4	37,0	53,0	16,0	100,0	
PEB-71S-MPB	71	2	316,41	313,62	279,0	150,0	25,4	37,0	53,0	16,0	100,0	
PEB-75S-MPB	75	2	334,24	331,44	296,0	150,0	25,4	37,0	53,0	16,0	100,0	
PEB-80S-MPB	80	2	356,52	353,72	319,0	150,0	25,4	37,0	53,0	16,0	100,0	
PEB-90S-MPB	90	2	401,08	398,29	358,0	150,0	25,4	37,0	53,0	16,0	100,0	GG
PEB-112S-MPB	112	3	499,12	496,33	456,0	150,0	25,4	37,0	53,0	16,0	100,0	
PEB-140S-MPB	140	3	623,91	621,11	581,0	150,0	25,4	37,0	53,0	16,0	100,0	
PEB-168S-MPB	168	3	748,69	745,89	706,0	150,0	25,4	37,0	53,0	16,0	100,0	

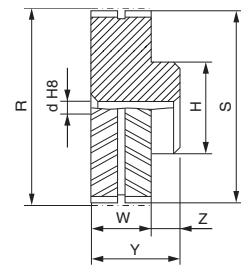

1

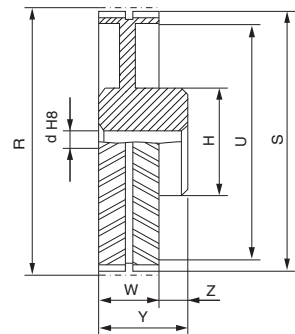

2

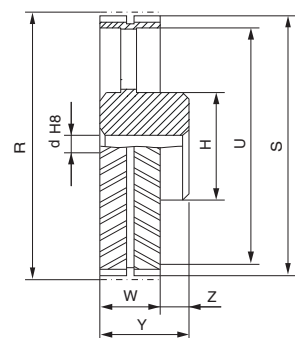

3

## Type "Green" G - width W = 52,5 mm

14M

Code	Teeth nr.	Type	R [mm]	S [mm]	U [mm]	H [mm]	d [mm]	W [mm]	Y [mm]	Z [mm]	Max bore [mm]	Material
PEG-28S-MPB	28	1	124,78	121,99	-	109,0	25,4	54,5	74,5	20,0	73,0	steel
PEG-30S-MPB	30	1	133,69	130,90	-	117,5	25,4	54,5	74,5	20,0	78,0	
PEG-32S-MPB	32	1	142,61	139,81	-	126,5	25,4	54,5	74,5	20,0	84,0	
PEG-34S-MPB	34	1	151,52	148,73	-	135,5	25,4	54,5	74,5	20,0	90,0	
PEG-36S-MPB	36	1	160,43	157,64	-	141,0	25,4	54,5	70,5	16,0	94,0	
PEG-38S-MPB	38	1	169,35	166,55	-	150,0	25,4	54,5	70,5	16,0	100,0	
PEG-40S-MPB	40	1	178,26	175,46	-	159,0	25,4	54,5	70,5	16,0	106,0	
PEG-43S-MPB	43	1	191,63	188,83	-	172,0	25,4	54,5	70,5	16,0	115,0	
PEG-45S-MPB	45	1	200,54	197,75	-	181,0	25,4	54,5	70,5	16,0	121,0	
PEG-48S-MPB	48	1	213,91	211,12	-	195,0	25,4	54,5	70,5	16,0	130,0	
PEG-50S-MPB	50	2	222,82	220,03	185,0	150,0	25,4	54,5	70,5	16,0	100,0	GS400
PEG-56S-MPB	56	2	249,56	246,77	212,0	150,0	25,4	54,5	70,5	16,0	100,0	
PEG-60S-MPB	60	2	267,39	264,59	230,0	150,0	25,4	54,5	70,5	16,0	100,0	
PEG-63S-MPB	63	2	280,76	277,96	243,0	150,0	25,4	54,5	70,5	16,0	100,0	
PEG-71S-MPB	71	2	316,41	313,62	279,0	150,0	25,4	54,5	70,5	16,0	100,0	
PEG-75S-MPB	75	2	334,24	331,44	296,0	150,0	25,4	54,5	70,5	16,0	100,0	
PEG-80S-MPB	80	2	356,52	353,72	319,0	150,0	25,4	54,5	70,5	16,0	100,0	
PEG-90S-MPB	90	2	401,08	398,29	358,0	180,0	25,4	54,5	70,5	16,0	120,0	GG
PEG-112S-MPB	112	3	499,12	496,33	456,0	180,0	25,4	54,5	70,5	16,0	120,0	
PEG-140S-MPB	140	3	623,91	621,11	581,0	200,0	25,4	54,5	70,5	16,0	133,0	
PEG-168S-MPB	168	3	748,69	745,89	706,0	200,0	25,4	54,5	70,5	16,0	133,0	

GS400 = spheroidal cast iron - GG = grey cast iron

# Dimensions of timing pulleys EAGLE - solid hub



Type "Orange" O - belt width W = 70 mm

14M

Code	Teeth nr.	Type	R [mm]	S [mm]	U [mm]	H [mm]	d [mm]	W [mm]	Y [mm]	Z [mm]	Max bore [mm]	Material
PEO-28S-MPB	28	1	124,78	121,99	-	109,0	25,4	72,0	92,0	20,0	73,0	steel
PEO-30S-MPB	30	1	133,69	130,90	-	117,5	25,4	72,0	92,0	20,0	78,0	
PEO-32S-MPB	32	1	142,61	139,81	-	126,5	25,4	72,0	98,0	26,0	84,0	
PEO-34S-MPB	34	1	151,52	148,73	-	135,5	25,4	72,0	98,0	26,0	90,0	
PEO-36S-MPB	36	1	160,43	157,64	-	144,0	25,4	72,0	98,0	26,0	95,0	
PEO-38S-MPB	38	1	169,35	166,55	-	153,0	25,4	72,0	98,0	26,0	101,0	
PEO-40S-MPB	40	1	178,26	175,46	-	162,0	25,4	72,0	98,0	26,0	107,0	
PEO-43S-MPB	43	1	191,63	188,83	-	174,0	25,4	72,0	88,0	16,0	116,0	
PEO-45S-MPB	45	1	200,54	197,75	-	183,0	25,4	72,0	88,0	16,0	122,0	
PEO-48S-MPB	48	1	213,91	211,12	-	197,0	25,4	72,0	88,0	16,0	131,0	
PEO-50S-MPB	50	1	222,82	220,03	-	205,0	25,4	72,0	88,0	16,0	137,0	
PEO-56S-MPB	56	1	249,56	246,77	-	230,0	25,4	72,0	88,0	16,0	153,0	
PEO-60S-MPB	60	2	267,39	264,59	230,0	150,0	25,4	72,0	88,0	16,0	100,0	GS400
PEO-63S-MPB	63	2	280,76	277,96	243,0	150,0	25,4	72,0	88,0	16,0	100,0	
PEO-71S-MPB	71	2	316,41	313,62	279,0	150,0	25,4	72,0	88,0	16,0	100,0	
PEO-75S-MPB	75	2	334,24	331,44	296,0	180,0	25,4	72,0	88,0	16,0	120,0	
PEO-80S-MPB	80	2	356,52	353,72	319,0	180,0	25,4	72,0	88,0	16,0	120,0	
PEO-90S-MPB	90	2	401,08	398,29	358,0	200,0	25,4	72,0	88,0	16,0	133,0	GG
PEO-112S-MPB	112	3	499,12	496,33	456,0	200,0	25,4	72,0	88,0	16,0	133,0	
PEO-140S-MPB	140	3	623,91	621,11	581,0	220,0	25,4	72,0	88,0	16,0	147,0	
PEO-168S-MPB	168	3	748,69	745,89	706,0	220,0	25,4	72,0	88,0	16,0	147,0	

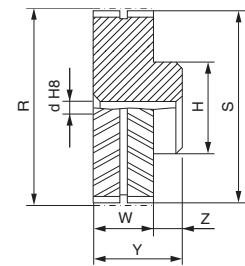

1

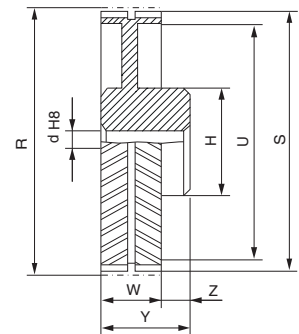

2

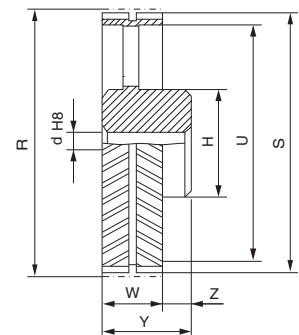

3

Type "Red" R - belt width W = 105 mm

14M

Code	Teeth nr.	Type	R [mm]	S [mm]	U [mm]	H [mm]	d [mm]	W [mm]	Y [mm]	Z [mm]	Max bore [mm]	Material
PER-28S-MPB	28	1	124,78	121,99	-	109,0	25,4	107,0	133,0	26,0	73,0	steel
PER-30S-MPB	30	1	133,69	130,90	-	117,5	25,4	107,0	133,0	26,0	78,0	
PER-32S-MPB	32	1	142,61	139,81	-	126,5	25,4	107,0	133,0	26,0	84,0	
PER-34S-MPB	34	1	151,52	148,73	-	135,5	25,4	107,0	133,0	26,0	90,0	
PER-36S-MPB	36	1	160,43	157,64	-	144,0	25,4	107,0	133,0	26,0	96,0	
PER-38S-MPB	38	1	169,35	166,55	-	153,0	25,4	107,0	133,0	26,0	102,0	
PER-40S-MPB	40	1	178,26	175,46	-	162,0	25,4	107,0	133,0	26,0	108,0	
PER-43S-MPB	43	1	191,63	188,83	-	174,0	25,4	107,0	133,0	26,0	117,0	
PER-45S-MPB	45	1	200,54	197,75	-	183,0	25,4	107,0	123,0	16,0	122,0	
PER-48S-MPB	48	1	213,91	211,12	-	197,0	25,4	107,0	123,0	16,0	131,0	
PER-50S-MPB	50	1	222,82	220,03	-	205,0	25,4	107,0	123,0	16,0	137,0	
PER-56S-MPB	56	1	249,56	246,77	-	230,0	25,4	107,0	123,0	16,0	153,0	
PER-60S-MPB	60	2	267,39	264,59	230,0	180,0	25,4	107,0	123,0	16,0	120,0	GS400
PER-63S-MPB	63	2	280,76	277,96	243,0	180,0	25,4	107,0	123,0	16,0	120,0	
PER-71S-MPB	71	2	316,41	313,62	279,0	200,0	25,4	107,0	123,0	16,0	133,0	
PER-75S-MPB	75	2	334,24	331,44	296,0	200,0	25,4	107,0	123,0	16,0	133,0	
PER-80S-MPB	80	2	356,52	353,72	319,0	200,0	25,4	107,0	123,0	16,0	133,0	
PER-90S-MPB	90	2	401,08	398,29	358,0	220,0	25,4	107,0	123,0	16,0	147,0	GG
PER-112S-MPB	112	3	499,12	496,33	456,0	220,0	25,4	107,0	123,0	16,0	147,0	
PER-140S-MPB	140	3	623,91	621,11	581,0	240,0	25,4	107,0	123,0	16,0	160,0	
PER-168S-MPB	168	3	748,69	745,89	706,0	240,0	25,4	107,0	123,0	16,0	160,0	

GS400 = spheroidal cast iron - GG = grey cast iron

# Dimensions of timing pulleys EAGLE - mounting taper bushing SER-SIT® passo 14M



Part Number	PBE	B	-32S	-2517
EAGLE timing pulley - solid hub				
Belt width				
Number of teeth				
Taper bushing size				

## Type "Blue" B - belt width W = 35 mm

14M

Code	Teeth nr.	Type	Taper bushing SER-SIT®	R [mm]	S [mm]	U [mm]	H [mm]	W [mm]	Y [mm]	Z [mm]	Material
PBEB-28S-2012	28	4	2012	124,78	121,99	82,0	-	37,0	32,0	5,0	steel
PBEB-30S-2517	30	1	2517	133,69	130,90	-	114,0	37,0	45,0	8,0	
PBEB-32S-2517	32	1	2517	142,61	139,81	-	123,0	37,0	45,0	8,0	
PBEB-34S-2517	34	1	2517	151,52	148,73	-	132,0	37,0	45,0	8,0	
PBEB-36S-3020	36	1	3020	160,43	157,64	-	141,0	37,0	51,0	14,0	
PBEB-38S-3020	38	1	3020	169,35	166,55	-	150,0	37,0	51,0	14,0	
PBEB-40S-3020	40	1	3020	178,26	175,46	-	159,0	37,0	51,0	14,0	
PBEB-43S-3020	43	1	3020	191,63	188,83	-	172,0	37,0	51,0	14,0	
PBEB-45S-3020	45	1	3020	200,54	197,75	-	181,0	37,0	51,0	14,0	
PBEB-48S-3020	48	1	3020	213,91	211,12	-	195,0	37,0	51,0	14,0	
PBEB-50S-3020	50	2	3020	222,82	220,03	180,0	150,0	37,0	51,0	14,0	GS400
PBEB-56S-3020	56	2	3020	249,56	246,77	207,0	150,0	37,0	51,0	14,0	
PBEB-60S-3020	60	2	3020	267,39	264,59	225,0	150,0	37,0	51,0	14,0	
PBEB-63S-3020	63	2	3020	280,76	277,96	238,0	150,0	37,0	51,0	14,0	
PBEB-71S-3020	71	2	3020	316,41	313,62	274,0	150,0	37,0	51,0	14,0	
PBEB-75S-3020	75	2	3020	334,24	331,44	291,0	150,0	37,0	51,0	14,0	
PBEB-80S-3020	80	2	3020	356,52	353,72	314,0	150,0	37,0	51,0	14,0	GG
PBEB-90S-3020	90	2	3020	401,08	398,29	358,0	150,0	37,0	51,0	14,0	
PBEB-112S-3020	112	3	3020	499,12	496,33	456,0	150,0	37,0	51,0	14,0	
PBEB-140S-3020	140	3	3020	623,91	621,11	581,0	150,0	37,0	51,0	14,0	
PBEB-168S-3020	168	3	3020	748,69	745,89	706,0	150,0	37,0	51,0	14,0	

GS400 = spheroidal cast iron - GG = grey cast iron

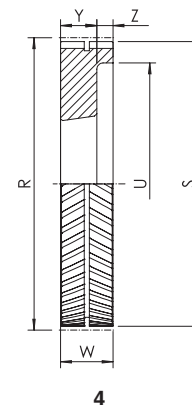
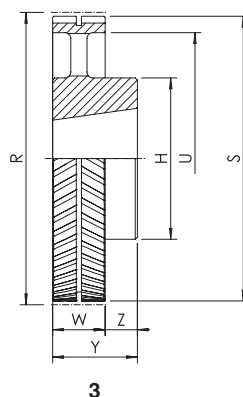
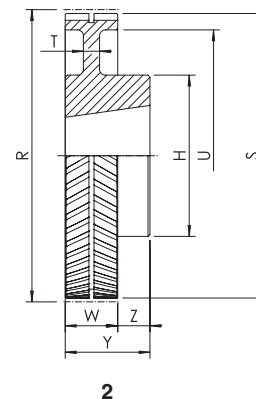
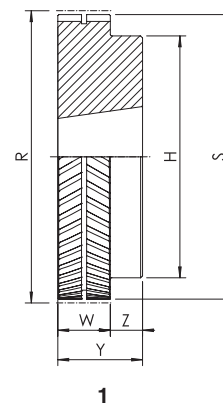



# Dimensions of timing pulleys EAGLE - mounting taper bushing SER-SIT®

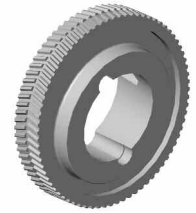

Type "Green" G - belt width  $W = 52,5$  mm

14M

Code	Teeth nr.	Type	Taper bushing SER-SIT®	R [mm]	S [mm]	U [mm]	H [mm]	W [mm]	Y [mm]	Z [mm]	Material
PBEG-28S-2517	28	4	2517	124,78	121,99	86,0	-	54,5	45,0	9,5	steel
PBEG-30S-2517	30	4	2517	133,69	130,90	90,0	-	54,5	45,0	9,5	
PBEG-32S-2517	32	4	2517	142,61	139,81	100,0	-	54,5	45,0	9,5	
PBEG-34S-2517	34	4	2517	151,52	148,73	108,0	-	54,5	45,0	9,5	
PBEG-36S-3020	36	4	3020	160,43	157,64	118,0	-	54,5	51,0	3,5	
PBEG-38S-3020	38	4	3020	169,35	166,55	126,0	-	54,5	51,0	3,5	
PBEG-40S-3020	40	4	3020	178,26	175,46	135,0	-	54,5	51,0	3,5	
PBEG-43S-3020	43	4	3020	191,63	188,83	148,0	-	54,5	51,0	3,5	
PBEG-45S-3020	45	4	3020	200,54	197,75	158,0	-	54,5	51,0	3,5	
PBEG-48S-3020	48	4	3020	213,91	211,12	171,0	-	54,5	51,0	3,5	
PBEG-50S-3020	50	8	3020	222,82	220,03	180,0	150,0	54,5	51,0	3,5	GS400
PBEG-56S-3020	56	8	3020	249,56	246,77	207,0	150,0	54,5	51,0	3,5	
PBEG-60S-3020	60	8	3020	267,39	264,59	225,0	150,0	54,5	51,0	3,5	
PBEG-63S-3020	63	8	3020	280,76	277,96	238,0	150,0	54,5	51,0	3,5	
PBEG-71S-3020	71	8	3020	316,41	313,62	274,0	150,0	54,5	51,0	3,5	
PBEG-75S-3020	75	8	3020	334,24	331,44	291,0	150,0	54,5	51,0	3,5	
PBEG-80S-3020	80	8	3020	356,52	353,72	314,0	150,0	54,5	51,0	3,5	
PBEG-90S-3020	90	8	3020	401,08	398,29	358,0	180,0	54,5	51,0	3,5	GG
PBEG-112S-3020	112	10	3020	499,12	496,33	456,0	180,0	54,5	51,0	3,5	
PBEG-140S-3020	140	10	3020	623,91	621,11	581,0	200,0	54,5	51,0	3,5	
PBEG-168S-3020	168	10	3020	748,69	745,89	706,0	200,0	54,5	51,0	3,5	

GS400 = spheroidal cast iron - GG = grey cast iron

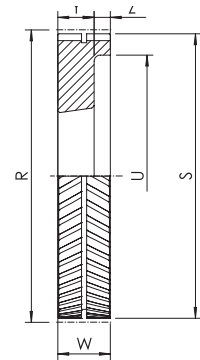

4

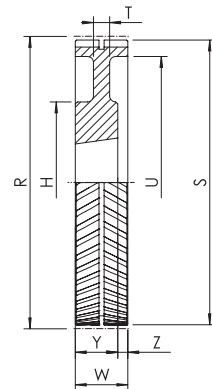

8

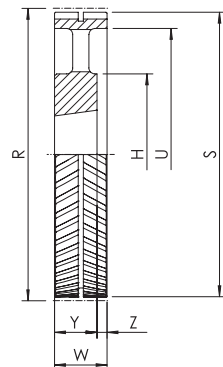

10



# Dimensions of timing pulleys EAGLE - mounting taper bushing SER-SIT®

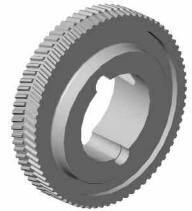

Type "Orange" O - belt width  $W = 70 \text{ mm}$

14M

Code	Teeth nr.	Type	Taper bushing SER-SIT®	R [mm]	S [mm]	U [mm]	H [mm]	W [mm]	Y [mm]	Z [mm]	Material
PBEO-28S-2517	28	4	2517	124,78	121,99	86,0	-	72,0	45,0	27,0	steel
PBEO-30S-2517	30	4	2517	133,69	130,90	90,0	-	72,0	45,0	27,0	
PBEO-32S-2517	32	4	2517	142,61	139,81	100,0	-	72,0	45,0	27,0	
PBEO-34S-3030	34	1	3030	151,52	148,73	-	135,5	72,0	76,0	4,0	
PBEO-36S-3030	36	1	3030	160,43	157,64	-	144,0	72,0	76,0	4,0	
PBEO-38S-3030	38	1	3030	169,35	166,55	-	153,0	72,0	76,0	4,0	
PBEO-40S-3030	40	1	3030	178,26	175,46	-	162,0	72,0	76,0	4,0	
PBEO-43S-3535	43	1	3535	191,63	188,83	-	174,0	72,0	89,0	17,0	
PBEO-45S-3535	45	1	3535	200,54	197,75	-	183,0	72,0	89,0	17,0	
PBEO-48S-3535	48	1	3535	213,91	211,12	-	197,0	72,0	89,0	17,0	
PBEO-50S-3535	50	1	3535	222,82	220,03	-	205,0	72,0	89,0	17,0	
PBEO-56S-3535	56	1	3535	249,56	246,77	-	230,0	72,0	89,0	17,0	
PBEO-60S-3030	60	2	3030	267,39	264,59	225,0	150,0	72,0	76,0	4,0	GS400
PBEO-63S-3030	63	2	3030	280,76	277,96	238,0	150,0	72,0	76,0	4,0	
PBEO-71S-3030	71	2	3030	316,41	313,62	274,0	150,0	72,0	76,0	4,0	
PBEO-75S-3535	75	2	3535	334,24	331,44	291,0	180,0	72,0	89,0	17,0	
PBEO-80S-3535	80	2	3535	356,52	353,72	314,0	180,0	72,0	89,0	17,0	
PBEO-90S-3535	90	2	3535	401,08	398,29	358,0	200,0	72,0	89,0	17,0	GG
PBEO-112S-3535	112	3	3535	499,12	496,33	456,0	200,0	72,0	89,0	17,0	
PBEO-140S-3535	140	3	3535	623,91	621,11	581,0	220,0	72,0	89,0	17,0	
PBEO-168S-3535	168	3	3535	748,69	745,89	706,0	220,0	72,0	89,0	17,0	

GS400 = spheroidal cast iron - GG = grey cast iron

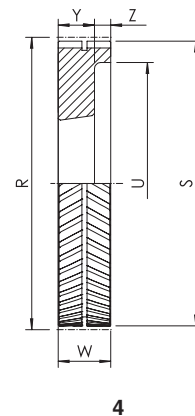
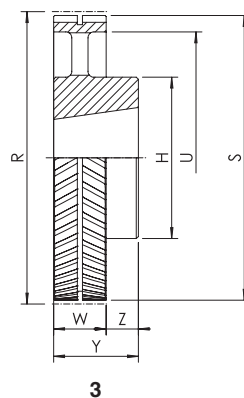
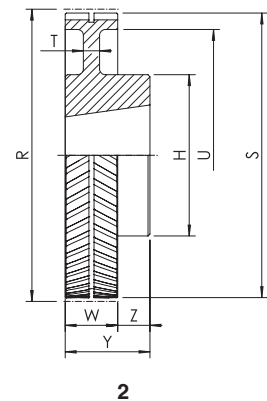
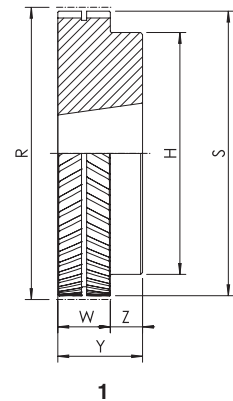

# Dimensions of timing pulleys EAGLE - mounting taper bushing SER-SIT®

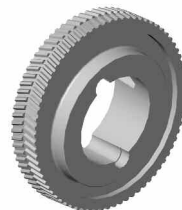

Type "Red" R - belt width W = 105 mm

14M

Code	Teeth nr.	Type	Taper bushing SER-SIT®	R [mm]	S [mm]	U [mm]	H [mm]	W [mm]	Y [mm]	Z [mm]	Material
PBER -28S-2517	28	9	2517	124,78	121,99	86,0	-	107,0	45,0	31,0	steel
PBER -30S-2517	30	9	2517	133,69	130,90	90,0	-	107,0	45,0	31,0	
PBER -32S-2517	32	9	2517	142,61	139,81	100,0	-	107,0	45,0	31,0	
PBER -34S-3030	34	9	3030	151,52	148,73	109,0	-	107,0	76,0	15,5	
PBER -36S-3030	36	9	3030	160,43	157,64	117,0	-	107,0	76,0	15,5	
PBER -38S-3030	38	9	3030	169,35	166,55	126,0	-	107,0	76,0	15,5	
PBER -40S-3030	40	9	3030	178,26	175,46	135,0	-	107,0	76,0	15,5	
PBER -43S-3535	43	4	3535	191,63	188,83	148,0	-	107,0	89,0	18,0	
PBER -45S-3535	45	4	3535	200,54	197,75	157,0	-	107,0	89,0	18,0	
PBER -48S-4040	48	4	4040	213,91	211,12	171,0	-	107,0	102,0	5,0	
PBER -50S-4040	50	4	4040	222,82	220,03	180,0	-	107,0	102,0	5,0	
PBER -56S-4040	56	4	4040	249,56	246,77	206,0	-	107,0	102,0	5,0	
PBER -60S-3535	60	8	3535	267,39	264,59	225,0	180,0	107,0	89,0	18,0	
PBER -63S-3535	63	8	3535	280,76	277,96	238,0	180,0	107,0	89,0	18,0	
PBER -71S-4040	71	8	4040	316,41	313,62	274,0	200,0	107,0	102,0	5,0	
PBER -75S-4040	75	8	4040	334,24	331,44	291,0	200,0	107,0	102,0	5,0	
PBER -80S-4040	80	8	4040	356,52	353,72	314,0	200,0	107,0	102,0	5,0	
PBER -90S-4040	90	8	4040	401,08	398,29	358,0	220,0	107,0	102,0	5,0	
PBER -112S-4040	112	10	4040	499,12	496,33	456,0	220,0	107,0	102,0	5,0	
PBER -140S-5050	140	3	5050	623,91	621,11	581,0	240,0	107,0	127,0	20,0	
PBER -168S-5050	168	3	5050	748,69	745,89	706,0	240,0	107,0	127,0	20,0	

GS400 = spheroidal cast iron - GG = grey cast iron

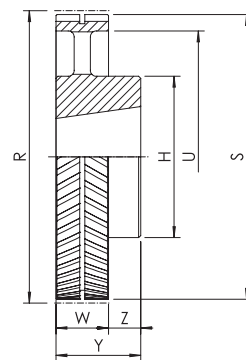

3

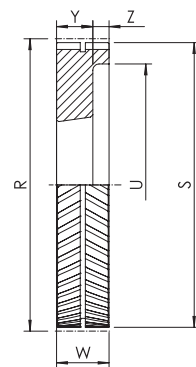

4

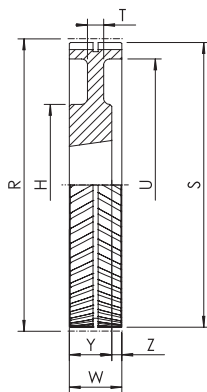

8

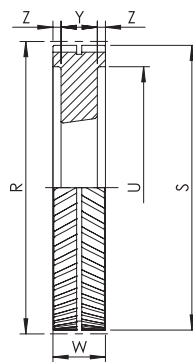

9

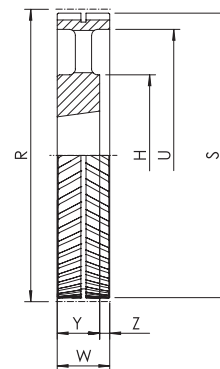

10

# Dimensions of timing pulleys EAGLE - solid hub aluminum type



Part Number	<b>PE5M 25 -15S -MPB</b>
EAGLE timing pulley - solid hub	
Belt width in mm	
Number of teeth	
Solid hub	

## PE5M - belt width 12,5 mm

5M

Code	Teeth nr.	Type	R [mm]	S [mm]	U [mm]	H [mm]	d [mm]	W [mm]	Y [mm]	Z [mm]	Material
PE5M12,5-15S-MP	15	1	23,87	22,91	-	17,0	6,0	13,5	19,5	6,0	aluminum
PE5M12,5-16S-MP	16	1	25,47	24,51	-	19,0	6,0	13,5	19,5	6,0	
PE5M12,5-18S-MP	18	1	28,65	27,69	-	22,0	6,0	13,5	19,5	6,0	
PE5M12,5-19S-MP	19	1	30,23	29,27	-	24,0	6,0	13,5	21,5	8,0	
PE5M12,5-20S-MP	20	1	31,83	30,87	-	25,0	6,0	13,5	21,5	8,0	
PE5M12,5-22S-MP	22	1	35,01	34,05	-	28,0	6,0	13,5	21,5	8,0	
PE5M12,5-24S-MP	24	1	38,19	37,23	-	32,0	6,0	13,5	21,5	8,0	
PE5M12,5-25S-MP	25	1	39,79	38,83	-	33,0	6,0	13,5	21,5	8,0	
PE5M12,5-26S-MP	26	1	41,38	40,42	-	35,0	6,0	13,5	21,5	8,0	
PE5M12,5-27S-MP	27	1	42,97	42,01	-	36,0	6,0	13,5	21,5	8,0	
PE5M12,5-28S-MP	28	1	44,56	43,60	-	38,0	6,0	13,5	21,5	8,0	
PE5M12,5-30S-MP	30	1	47,75	46,79	-	41,0	12,7	13,5	21,5	8,0	
PE5M12,5-32S-MP	32	1	50,93	49,97	-	44,0	12,7	13,5	21,5	8,0	
PE5M12,5-36S-MP	36	1	57,30	56,34	-	51,0	12,7	13,5	21,5	8,0	
PE5M12,5-40S-MP	40	1	63,66	62,70	-	57,0	12,7	13,5	24,5	11,0	
PE5M12,5-44S-MP	44	1	70,03	69,07	-	63,0	12,7	13,5	24,5	11,0	
PE5M12,5-48S-MP	48	1	76,39	75,43	-	70,0	12,7	13,5	24,5	11,0	
PE5M12,5-60S-MP	60	1	95,49	94,53	-	89,0	12,7	13,5	24,5	11,0	

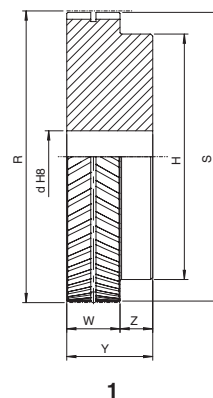

## PE5M - belt width 25 mm

5M

Code	Teeth nr.	Type	R [mm]	S [mm]	U [mm]	H [mm]	d [mm]	W [mm]	Y [mm]	Z [mm]	Material
PE5M25-15S-MPB	15	1	23,87	22,91	-	17,0	6,0	26,0	32,0	6,0	aluminum
PE5M25-16S-MPB	16	1	25,47	24,51	-	19,0	6,0	26,0	32,0	6,0	
PE5M25-18S-MPB	18	1	28,65	27,69	-	22,0	6,0	26,0	32,0	6,0	
PE5M25-19S-MPB	19	1	30,23	29,27	-	24,0	6,0	26,0	34,0	8,0	
PE5M25-20S-MPB	20	1	31,83	30,87	-	25,0	6,0	26,0	34,0	8,0	
PE5M25-22S-MPB	22	1	35,01	34,05	-	28,0	6,0	26,0	34,0	8,0	
PE5M25-24S-MPB	24	1	38,19	37,23	-	32,0	6,0	26,0	34,0	8,0	
PE5M25-25S-MPB	25	1	39,79	38,83	-	33,0	6,0	26,0	34,0	8,0	
PE5M25-26S-MPB	26	1	41,38	40,42	-	35,0	6,0	26,0	34,0	8,0	
PE5M25-27S-MPB	27	1	42,97	42,01	-	36,0	6,0	26,0	34,0	8,0	
PE5M25-28S-MPB	28	1	44,56	43,60	-	38,0	6,0	26,0	34,0	8,0	
PE5M25-30S-MPB	30	1	47,75	46,79	-	41,0	12,7	26,0	34,0	8,0	
PE5M25-32S-MPB	32	1	50,93	49,97	-	44,0	12,7	26,0	34,0	8,0	
PE5M25-36S-MPB	36	1	57,30	56,34	-	51,0	12,7	26,0	34,0	8,0	
PE5M25-40S-MPB	40	1	63,66	62,70	-	57,0	12,7	26,0	37,0	11,0	
PE5M25-44S-MPB	44	1	70,03	69,07	-	63,0	12,7	26,0	37,0	11,0	
PE5M25-48S-MPB	48	1	76,39	75,43	-	70,0	12,7	26,0	37,0	11,0	
PE5M25-60S-MPB	60	1	95,49	94,53	-	89,0	12,7	26,0	37,0	11,0	

# Dimensions of timing pulleys EAGLE - solid hub aluminum type



Part Number	PE	M	-20S	-MPB
EAGLE timing pulley - solid hub				
Belt width (25 mm)				
Number of teeth				
Solid hub				

## PEM - belt width 25 mm

8M

Code	Teeth nr.	Type	R [mm]	S [mm]	H [mm]	d [mm]	W [mm]	Y [mm]	Z [mm]	Max bore	Material
PEM-20S-MPB	20	1	50,93	49,55	41,0	12,7	26,0	38,0	12,0	27,0	aluminum
PEM-22S-MPB	22	1	56,02	54,64	46,0	12,7	26,0	38,0	12,0	31,0	
PEM-24S-MPB	24	1	61,12	59,74	51,0	12,7	26,0	42,0	16,0	34,0	
PEM-26S-MPB	26	1	66,21	64,83	58,0	12,7	26,0	42,0	16,0	39,0	
PEM-28S-MPB	28	1	71,30	69,92	62,0	12,7	26,0	42,0	16,0	41,0	
PEM-30S-MPB	30	1	76,39	75,01	67,0	12,7	26,0	42,0	16,0	45,0	
PEM-32S-MPB	32	1	81,49	80,11	72,0	12,7	26,0	42,0	16,0	48,0	
PEM-34S-MPB	34	1	86,58	85,20	77,0	12,7	26,0	42,0	16,0	51,0	
PEM-36S-MPB	36	1	91,67	90,29	82,0	12,7	26,0	42,0	16,0	55,0	
PEM-38S-MPB	38	1	96,77	95,39	87,0	12,7	26,0	42,0	16,0	58,0	
PEM-40S-MPB	40	1	101,86	100,48	92,0	12,7	26,0	42,0	16,0	62,0	
PEM-56S-MPB	56	1	142,60	141,22	133,0	12,7	26,0	42,0	16,0	89,0	
PEM-90S-MPB	90	2	229,18	227,80	120,0	25,4	26,0	42,0	16,0	80,0	

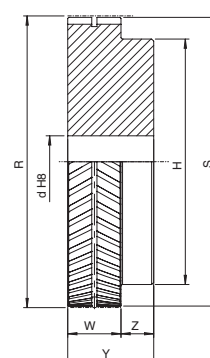

1

## PEL - belt width 50 mm

8M

Code	Teeth nr.	Type	R [mm]	S [mm]	H [mm]	d [mm]	W [mm]	Y [mm]	Z [mm]	Max bore	Material
PEL-20S-MPB	20	1	50,93	49,55	41,0	12,7	51,0	63,0	12,0	27,0	aluminum
PEL-22S-MPB	22	1	56,02	54,64	46,0	12,7	51,0	63,0	12,0	31,0	
PEL-24S-MPB	24	1	61,12	59,74	51,0	12,7	51,0	67,0	16,0	34,0	
PEL-26S-MPB	26	1	66,21	64,83	58,0	12,7	51,0	67,0	16,0	39,0	
PEL-28S-MPB	28	1	71,30	69,92	62,0	12,7	51,0	67,0	16,0	41,0	
PEL-30S-MPB	30	1	76,39	75,01	67,0	12,7	51,0	67,0	16,0	45,0	
PEL-32S-MPB	32	1	81,49	80,11	72,0	12,7	51,0	67,0	16,0	48,0	
PEL-34S-MPB	34	1	86,58	85,20	77,0	12,7	51,0	67,0	16,0	51,0	
PEL-36S-MPB	36	1	91,67	90,29	82,0	12,7	51,0	67,0	16,0	55,0	
PEL-38S-MPB	38	1	96,77	95,39	87,0	12,7	51,0	67,0	16,0	58,0	
PEL-40S-MPB	40	1	101,86	100,48	92,0	12,7	51,0	67,0	16,0	62,0	
PEL-56S-MPB	56	1	142,60	141,22	133,0	12,7	51,0	67,0	16,0	89,0	
PEL-90S-MPB	90	2	229,18	227,80	120,0	25,4	51,0	67,0	16,0	80,0	

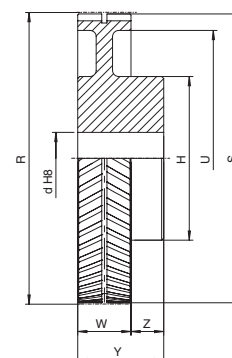

2

# Dimensions of timing pulleys EAGLE - solid hub aluminum type



<b>Part Number</b>	<b>PE10M 25 -15S -MPB</b>
EAGLE timing pulley - solid hub	
Belt width (25 mm)	
Number of teeth	
Solid hub	

## PE10M - belt width 25 mm

10M

Code	Teeth nr.	Type	R [mm]	S [mm]	U [mm]	H [mm]	d [mm]	W [mm]	Y [mm]	Z [mm]	Max bore [mm]	Material
PE10M25-15S-MPB	15	1	47,75	45,75	-	35,0	12,70	26,0	36,0	10,0	23,0	aluminum
PE10M25-16S-MPB	16	1	50,93	48,93	-	38,0	12,70	26,0	36,0	10,0	25,0	
PE10M25-18S-MPB	18	1	57,30	55,30	-	44,0	12,70	26,0	36,0	10,0	30,0	
PE10M25-19S-MPB	19	1	60,48	58,48	-	47,0	12,70	26,0	36,0	10,0	32,0	
PE10M25-20S-MPB	20	1	63,66	61,66	-	51,0	12,70	26,0	36,0	10,0	34,0	
PE10M25-22S-MPB	22	1	70,03	68,03	-	57,0	12,70	26,0	36,0	10,0	38,0	
PE10M25-24S-MPB	24	1	76,39	74,39	-	63,0	12,70	26,0	36,0	10,0	42,0	
PE10M25-25S-MPB	25	1	79,58	77,58	-	67,0	12,70	26,0	36,0	10,0	44,0	
PE10M25-26S-MPB	26	1	82,76	80,76	-	70,0	12,70	26,0	36,0	10,0	47,0	
PE10M25-27S-MPB	27	1	85,94	83,94	-	73,0	12,70	26,0	36,0	10,0	49,0	
PE10M25-28S-MPB	28	1	89,13	87,13	-	76,0	12,70	26,0	36,0	10,0	51,0	
PE10M25-30S-MPB	30	1	95,49	93,49	-	82,0	12,70	26,0	36,0	10,0	55,0	
PE10M25-32S-MPB	32	1	101,86	99,86	-	89,0	12,70	26,0	36,0	10,0	59,0	
PE10M25-36S-MPB	36	1	114,59	112,59	-	102,0	12,70	26,0	36,0	10,0	68,0	
PE10M25-40S-MPB	40	1	127,32	125,32	-	114,0	12,70	26,0	36,0	10,0	76,0	
PE10M25-44S-MPB	44	1	140,06	138,06	-	127,0	12,70	26,0	36,0	10,0	85,0	
PE10M25-48S-MPB	48	1	152,79	150,79	-	140,0	12,70	26,0	36,0	10,0	93,0	
PE10M25-60S-MPB	60	2	190,99	188,99	162,0	110,0	25,40	26,0	36,0	10,0	65,0	

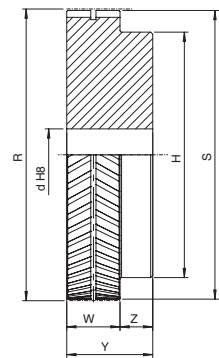

1

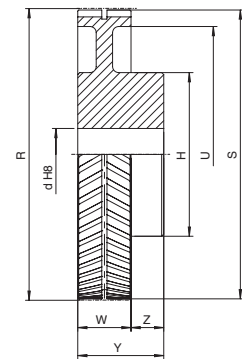

2

## PE10M - belt width 32 mm

10M

Code	Teeth nr.	Type	R [mm]	S [mm]	U [mm]	H [mm]	d [mm]	W [mm]	Y [mm]	Z [mm]	Max bore [mm]	Material
PE10M32-15S-MPB	15	1	47,75	45,75	-	35,0	12,70	33,0	43,0	10,0	23,0	aluminum
PE10M32-16S-MPB	16	1	50,93	48,93	-	38,0	12,70	33,0	43,0	10,0	25,0	
PE10M32-18S-MPB	18	1	57,30	55,30	-	44,0	12,70	33,0	43,0	10,0	30,0	
PE10M32-19S-MPB	19	1	60,48	58,48	-	47,0	12,70	33,0	43,0	10,0	32,0	
PE10M32-20S-MPB	20	1	63,66	61,66	-	51,0	12,70	33,0	43,0	10,0	34,0	
PE10M32-22S-MPB	22	1	70,03	68,03	-	57,0	12,70	33,0	43,0	10,0	38,0	
PE10M32-24S-MPB	24	1	76,39	74,39	-	63,0	12,70	33,0	43,0	10,0	42,0	
PE10M32-25S-MPB	25	1	79,58	77,58	-	67,0	12,70	33,0	43,0	10,0	44,0	
PE10M32-26S-MPB	26	1	82,76	80,76	-	70,0	12,70	33,0	43,0	10,0	47,0	
PE10M32-27S-MPB	27	1	85,94	83,94	-	73,0	12,70	33,0	43,0	10,0	49,0	
PE10M32-28S-MPB	28	1	89,13	87,13	-	76,0	12,70	33,0	43,0	10,0	51,0	
PE10M32-30S-MPB	30	1	95,49	93,49	-	82,0	12,70	33,0	43,0	10,0	55,0	
PE10M32-32S-MPB	32	1	101,86	99,86	-	89,0	12,70	33,0	43,0	10,0	59,0	
PE10M32-36S-MPB	36	1	114,59	112,59	-	102,0	12,70	33,0	43,0	10,0	68,0	
PE10M32-40S-MPB	40	1	127,32	125,32	-	114,0	12,70	33,0	43,0	10,0	76,0	
PE10M32-44S-MPB	44	1	140,06	138,06	-	127,0	12,70	33,0	43,0	10,0	85,0	
PE10M32-48S-MPB	48	1	152,79	150,79	-	140,0	12,70	33,0	43,0	10,0	93,0	
PE10M32-60S-MPB	60	2	190,99	188,99	161,0	178,0	25,40	33,0	43,0	10,0	105,0	

# Dimensions of timing pulleys EAGLE - solid hub aluminum type



## PE10M - belt width 50 mm

10M

Code	Teeth nr.	Type	R [mm]	S [mm]	U [mm]	H [mm]	d [mm]	W [mm]	Y [mm]	Z [mm]	Max bore [mm]	Material
PE10M50-15S-MPB	15	1	47,75	45,75	-	35,0	12,70	51,0	61,0	10,0	23,0	aluminum
PE10M50-16S-MPB	16	1	50,93	48,93	-	38,0	12,70	51,0	61,0	10,0	25,0	
PE10M50-18S-MPB	18	1	57,30	55,30	-	44,0	12,70	51,0	61,0	10,0	30,0	
PE10M50-19S-MPB	19	1	60,48	58,48	-	47,0	12,70	51,0	61,0	10,0	32,0	
PE10M50-20S-MPB	20	1	63,66	61,66	-	51,0	12,70	51,0	61,0	10,0	34,0	
PE10M50-22S-MPB	22	1	70,03	68,03	-	57,0	12,70	51,0	61,0	10,0	38,0	
PE10M50-24S-MPB	24	1	76,39	74,39	-	63,0	12,70	51,0	61,0	10,0	42,0	
PE10M50-25S-MPB	25	1	79,58	77,58	-	67,0	12,70	51,0	61,0	10,0	44,0	
PE10M50-26S-MPB	26	1	82,76	80,76	-	70,0	12,70	51,0	61,0	10,0	47,0	
PE10M50-27S-MPB	27	1	85,94	83,94	-	73,0	12,70	51,0	61,0	10,0	49,0	
PE10M50-28S-MPB	28	1	89,13	87,13	-	76,0	12,70	51,0	61,0	10,0	51,0	
PE10M50-30S-MPB	30	1	95,49	93,49	-	82,0	12,70	51,0	61,0	10,0	55,0	
PE10M50-32S-MPB	32	1	101,86	99,86	-	89,0	12,70	51,0	61,0	10,0	59,0	
PE10M50-36S-MPB	36	1	114,59	112,59	-	102,0	12,70	51,0	61,0	10,0	68,0	
PE10M50-40S-MPB	40	1	127,32	125,32	-	114,0	12,70	51,0	61,0	10,0	76,0	
PE10M50-44S-MPB	44	1	140,06	138,06	-	127,0	12,70	51,0	61,0	10,0	85,0	
PE10M50-48S-MPB	48	1	152,79	150,79	-	140,0	12,70	51,0	61,0	10,0	93,0	
PE10M50-60S-MPB	60	2	190,99	188,99	161,0	178,0	25,40	51,0	61,0	10,0	105,0	

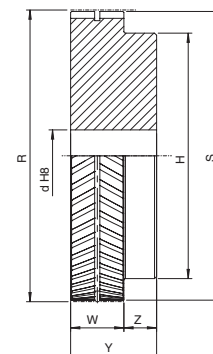

1

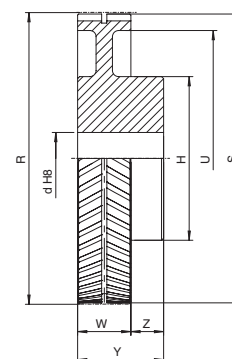

2